



inan makina®
SANAYİ VE TİCARET A.Ş.



PULVARIZER MODEL

PLV 15



MTB DEMOLITION ATTACHMENTS

MTB Demolition Attachments are used for primary and secondary concrete demolition. There is a wide range of MTB Attachments for different demolition applications.

PULVARIZER - PLV

PLV attachments are used for secondary operations such as pulverizing concrete and separating steel bars after the demolition of concrete structures. Thanks to PLV, the concrete debris and separated steel bars are made available for recycling. Other than this, PLV's can be used for primary and secondary demolition of concrete structures.



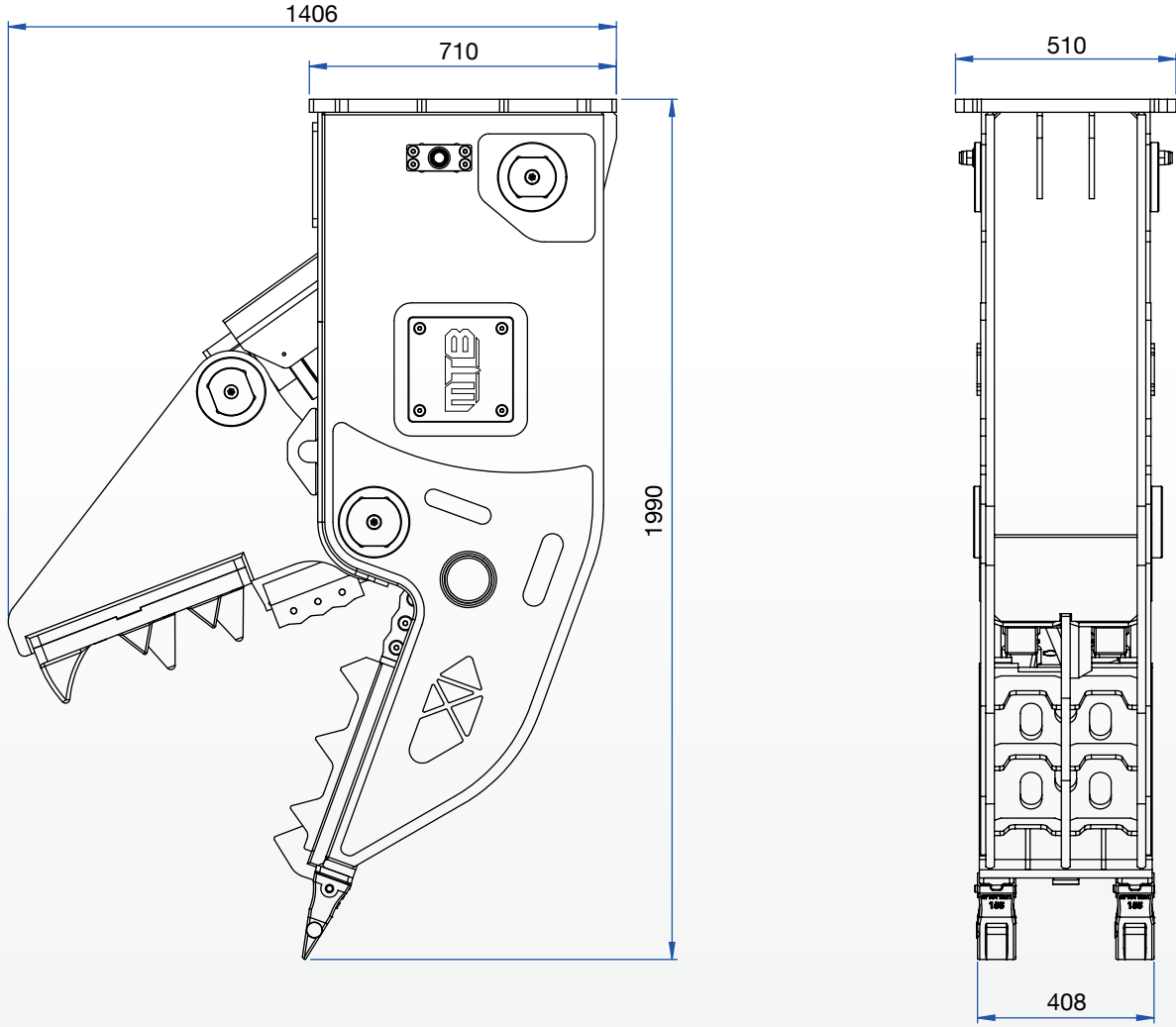

PLV 15

Working weight kg	1345 - 1545
Oil flow (Cylinder) lpm	200 - 250
Pressure (Cylinder) bar	350
Oil flow (Rotation) lpm	-
Pressure (Rotation) bar	-
Crushing force (Jaw tip) t	50
Cutting force t	210
Jaw opening mm	570
Jaw depth mm	790
Cutter length mm	180
Overall length mm	1990
Carrier weight t	14 - 20

Rev. 15062023



Factory

Bahçelievler OSB Mh. 11. Cd. No: 4A
59510 Kapaklı / Tekirdağ - TURKEY
+90 282 768 25 00

www.mtbbreakers.com - info@inanmakina.com



WARNING! The visuals and the information in this brochure are standard or optional depending on the version of the product.

İNAN MAKİNA A.Ş. saves the right to modify the values and designs shown in this brochure without notice.